

PICTOGRAMAS PARA ASOCIAR DIBUJO PALABRA



DUCHA

ducha



MOCHILA

mochila

PICTOGRAMAS PARA ASOCIAR DIBUJO PALABRA



LECHE

leche

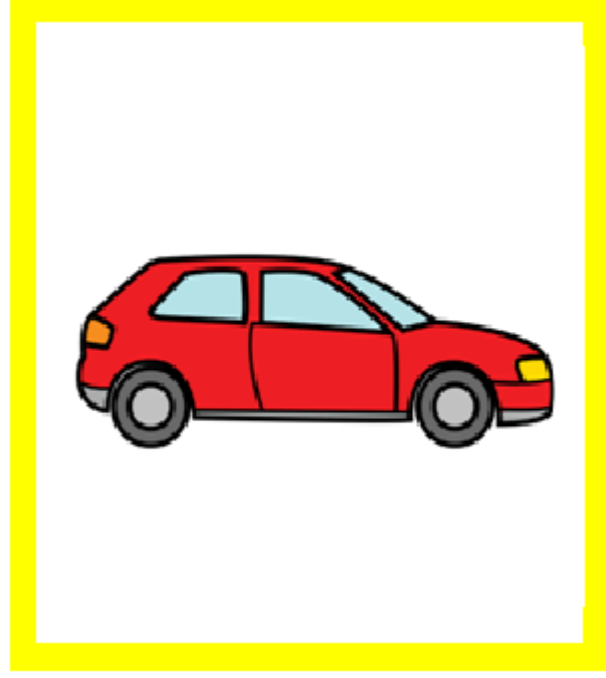

COCHE

coche

PICTOGRAMAS PARA ASOCIAR DIBUJO PALABRA

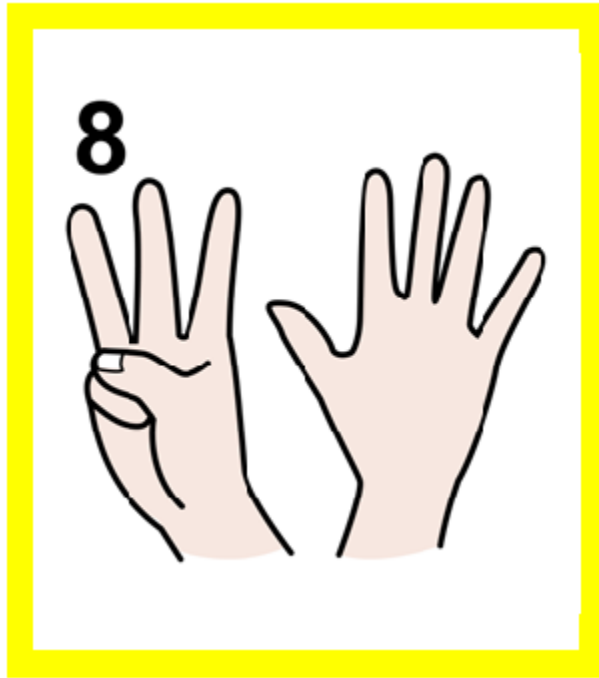

OCHO

ocho

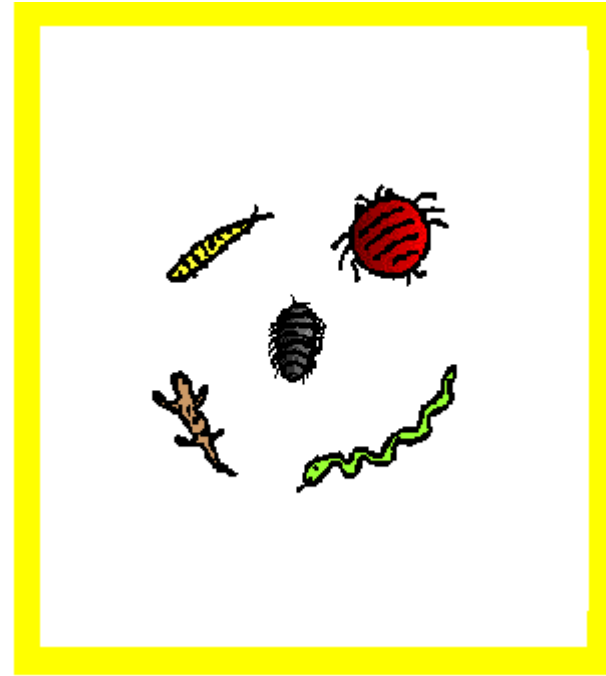

BICHOS

bichos

PICTOGRAMAS PARA ASOCIAR DIBUJO PALABRA

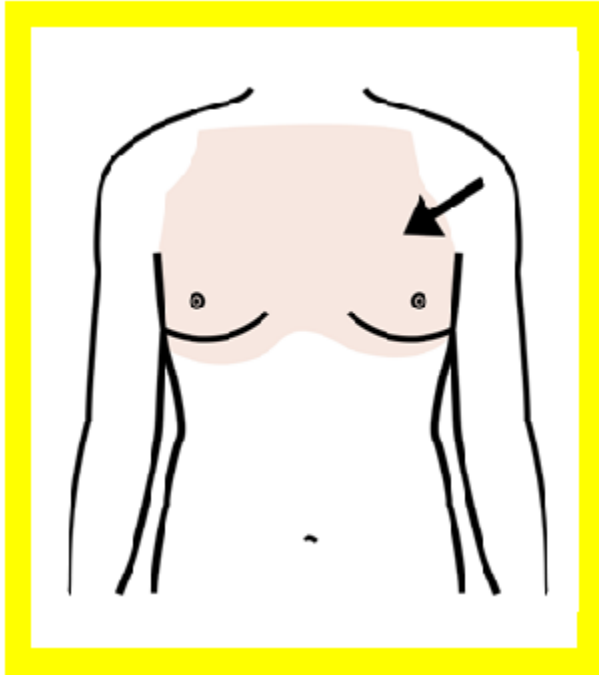

PECHO

pecho

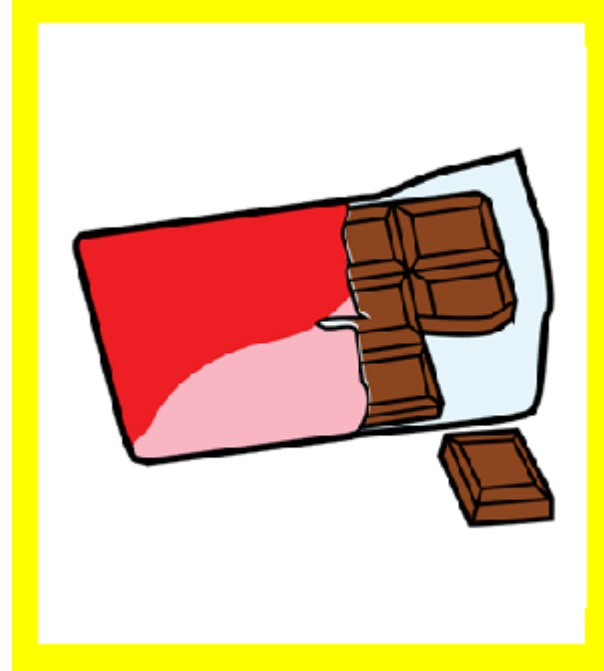

CHOCOLATE

chocolate

LEE Y COPIA

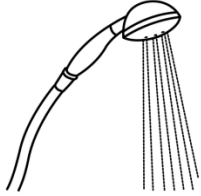

DUCHA



MOCHILA



LECHE



COCHE

LEE Y COPIA



8



OCHO



BICHOS

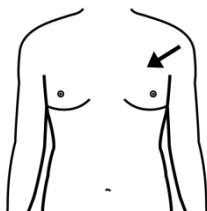

PECHO

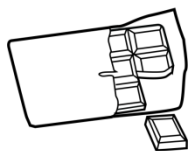

CHOCOLATE

Lee y copia

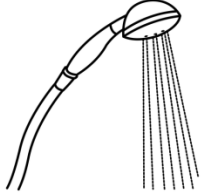
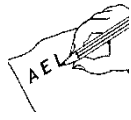

ducha



mochila



leche



coche

Lee y copia



8



ocho



lichos

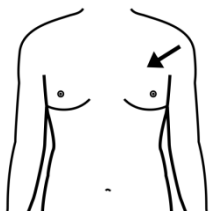

pecho

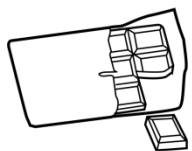

chocolate

PEGA LAS PALABRAS DE LA PÁGINA SIGUIENTE

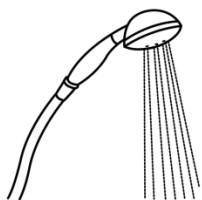

Empty rectangular box for labeling the shower head.

Empty rectangular box for labeling the backpack.

Empty rectangular box for labeling the glass and milk carton.

Empty rectangular box for labeling the car.

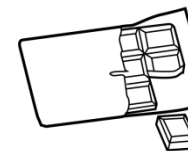
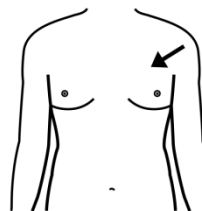

Empty rectangular box for labeling the hands.

Empty rectangular box for labeling the insects.

Empty rectangular box for labeling the chest.

Empty rectangular box for labeling the pills.

LEE, RECORTA Y PEGA CADA PALABRA EN LA PÁGINA ANTERIOR



DUCHA

MOCHILA

LECHE

COCHE

OCHO

BICHOS

PECHO

CHOCOLATE

Pega las palabras de la página siguiente

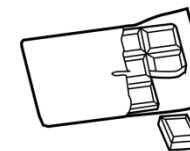
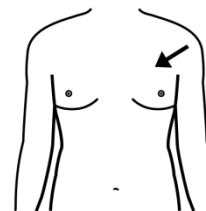
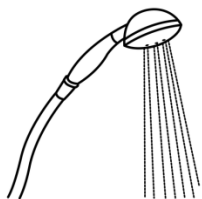

Lee, recorta y pega cada palabra en la página anterior



ducha

mochila

leche

coche

ocho

luchos

pecho

chocolate

LEE Y PEGA CADA DIBUJO DE LA PÁGINA SIGUIENTE EN SU CASILLA



DUCHA

MOCHILA

LECHE

COCHE

OCHO

BICHOS

PECHO

CHOCOLATE

RECORTA Y PEGA CADA DIBUJO EN LAS CASILLAS DE LA PÁGINA ANTERIOR

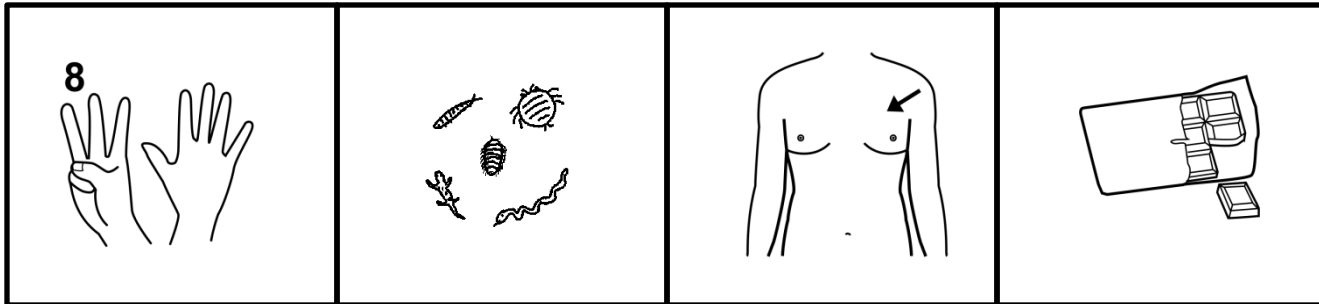
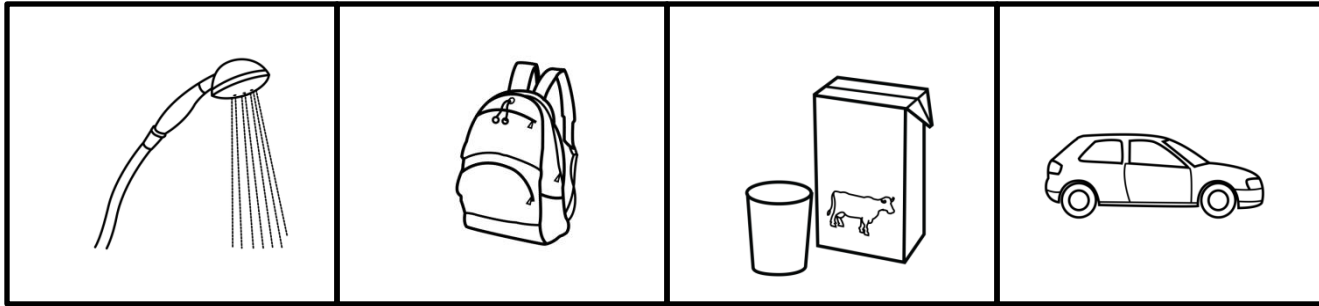
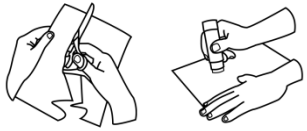

Lee y pega cada dibujo de la página siguiente en su casilla



ducha

--

mochila

--

leche

--

coche

--

ocho

--

luchos

--

pecho

--

chocolate

--

Recorta y pega cada dibujo en las casillas de la página anterior

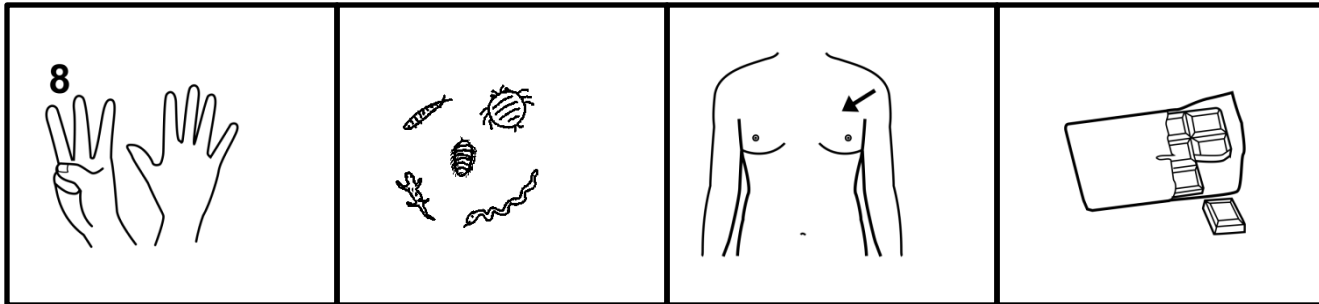
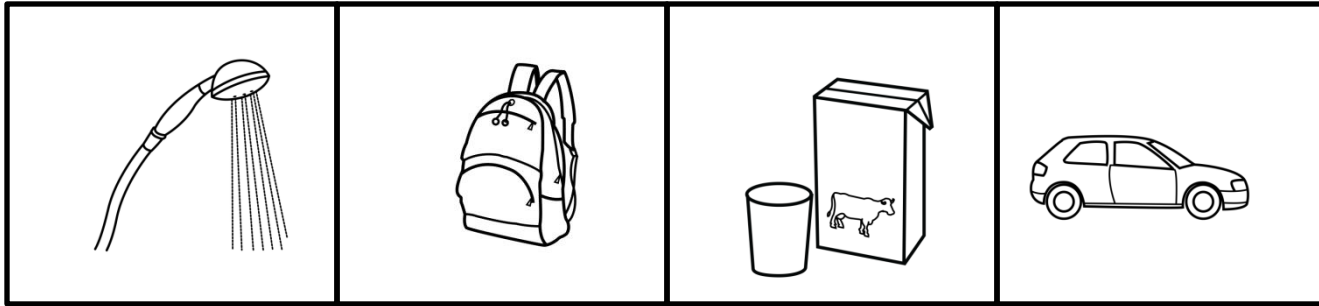

UNE EL DIBUJO CON SU NOMBRE

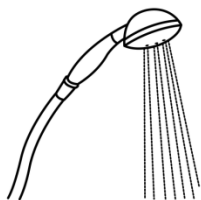
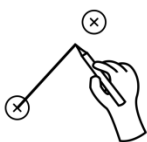

COCHE

CHOCOLATE



LECHE

PECHO



DUCHA

OCHO

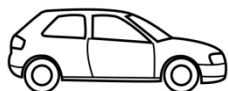
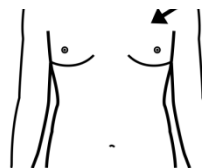

MOCHILA

BICHOS

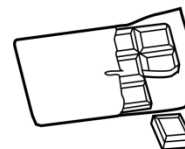

Une el dibujo con su nombre

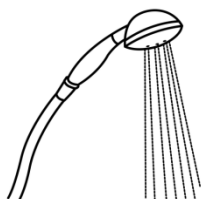
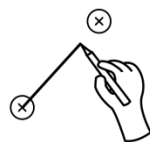

coche

chocolate



leche

pecho



ducha

ocho

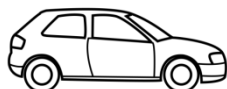
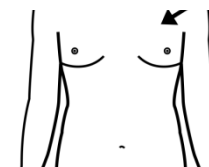

mochila

lichos

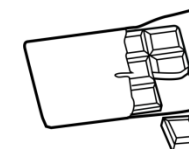

RODEA LA PALABRA CORRECTA CON UN CÍRCULO Y ESCRÍBELA

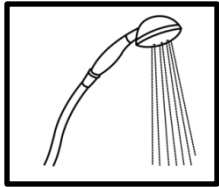
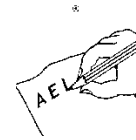

ABEJA DUCHA POLLO OCHO



SOPA ZUMO MOCHILA OJO

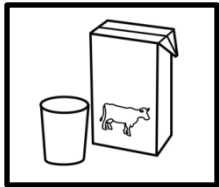

LECHE CONEJO PATATA BOTA

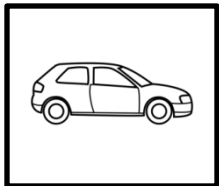

FEO BAJA SOFÁ COCHE

RODEA LA PALABRA CORRECTA CON UN CÍRCULO Y ESCRÍBELA

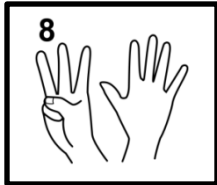

NIÑO FOTO OCHO BATA

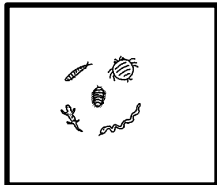

TIZA BICHOS PIJAMA OJO

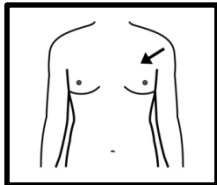

PECHO MANO MONO DAME

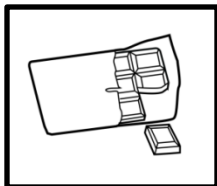

PALOMA PELOTA CHOCOLATE

Rodea la palabra correcta con un círculo y escribela

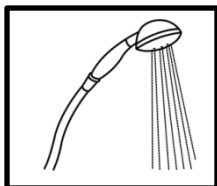

abeja ducha pollo ocho

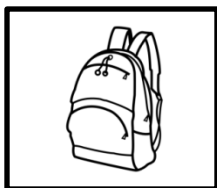

sopa zumo mochila ojo

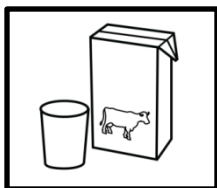

leche conejo patata bota

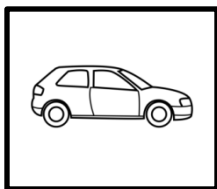

feo baja sopa coche

Rodea la palabra correcta con un círculo y escribela

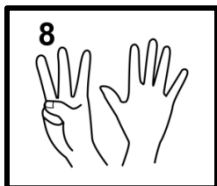

niño foto ocho bata

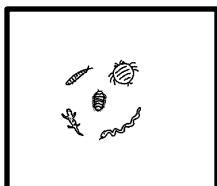

tiza lichos pijama ojo

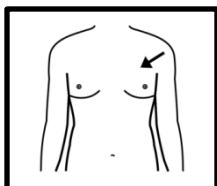

pecho mano mono dame

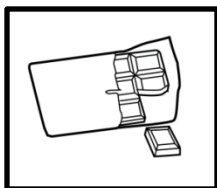

paloma patata chocolate



DIBUJA

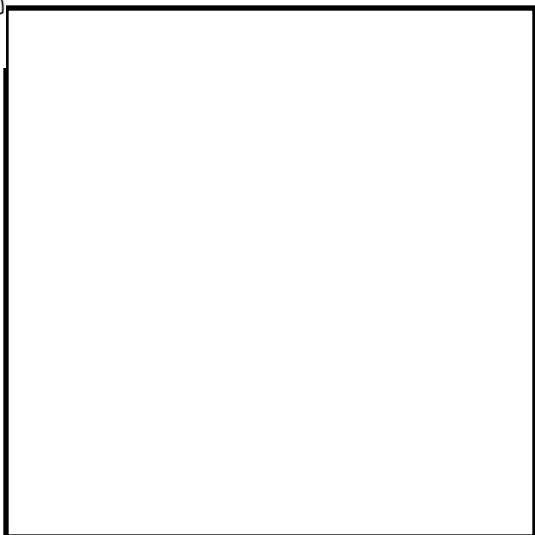

DUCHA

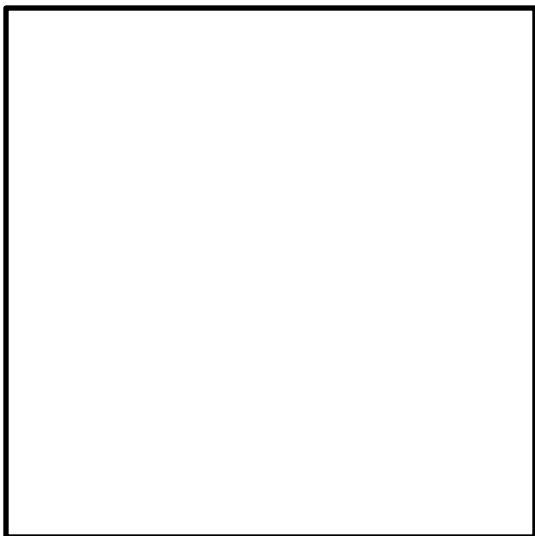

LECHE

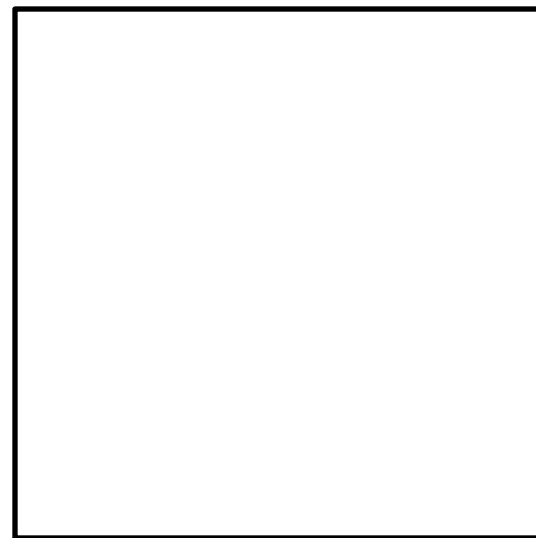

MOCHILA

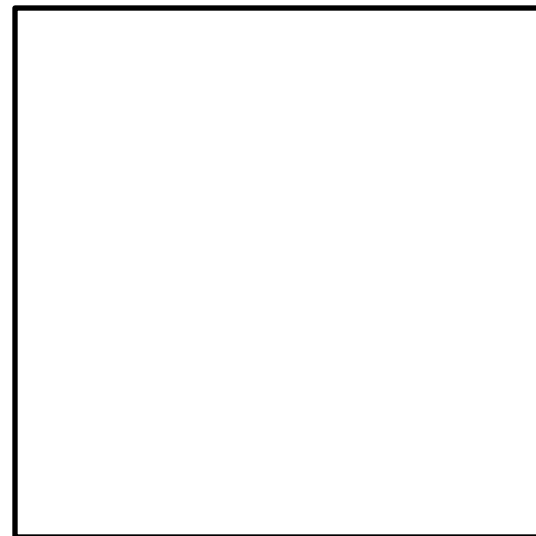

COCHE



DIBUJA

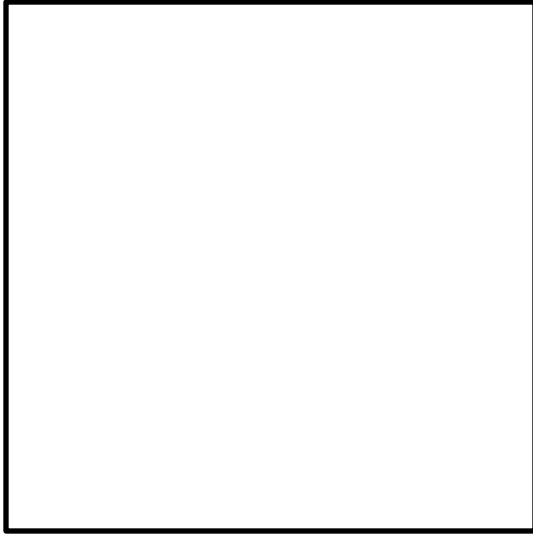

OCHO

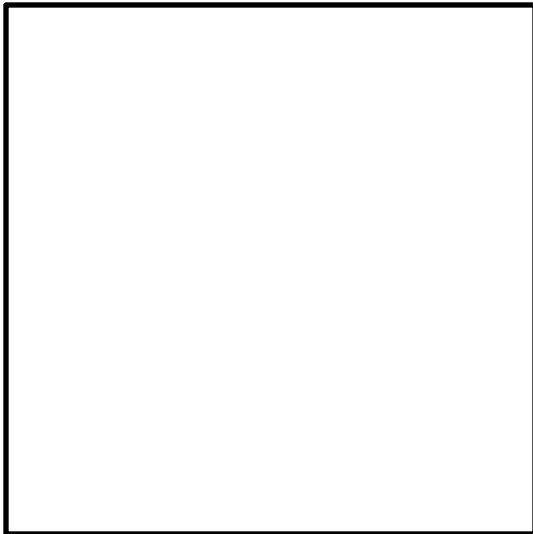

PECHO

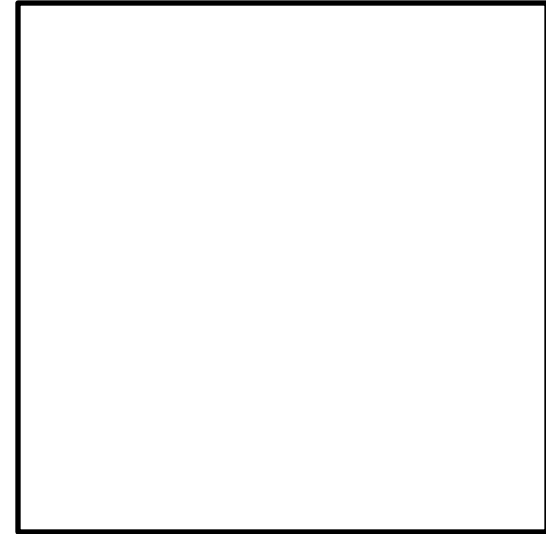

BICHO

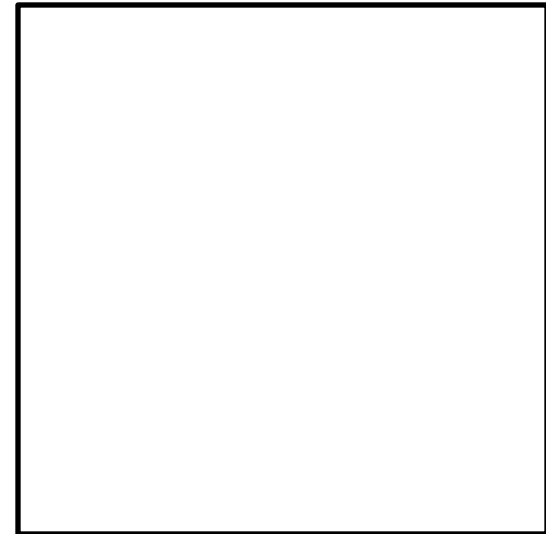

CHOCOLATE



Dibuja

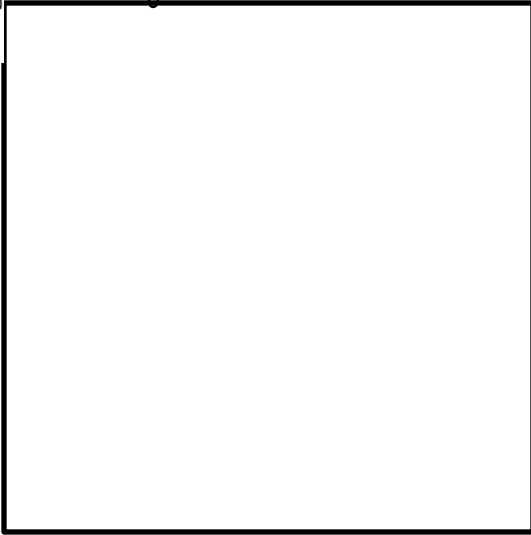

ducha

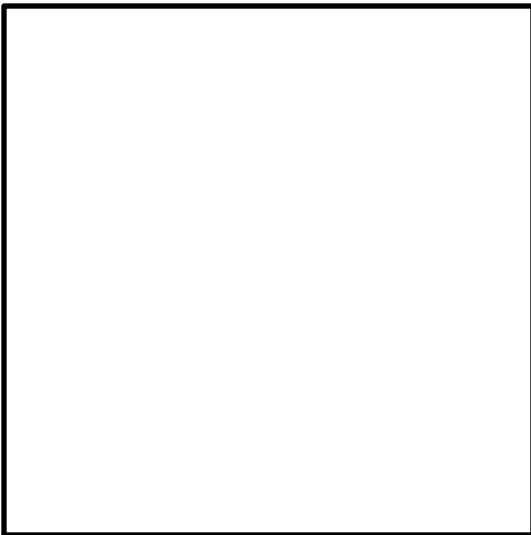

leche

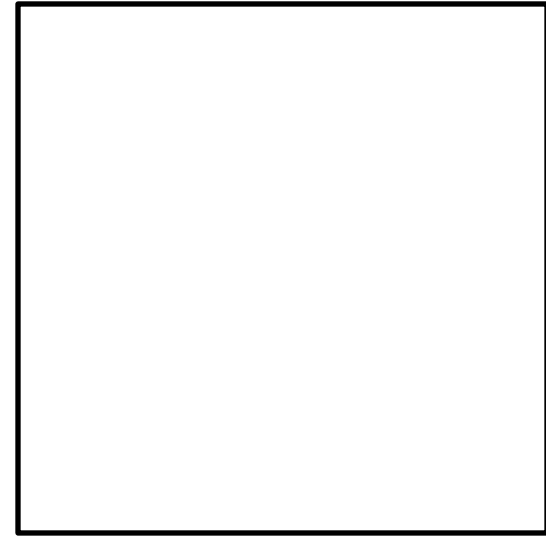

mochila

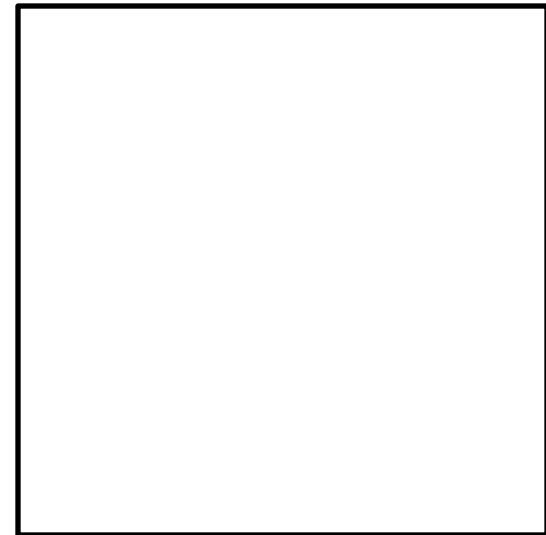

coche



Dibuja

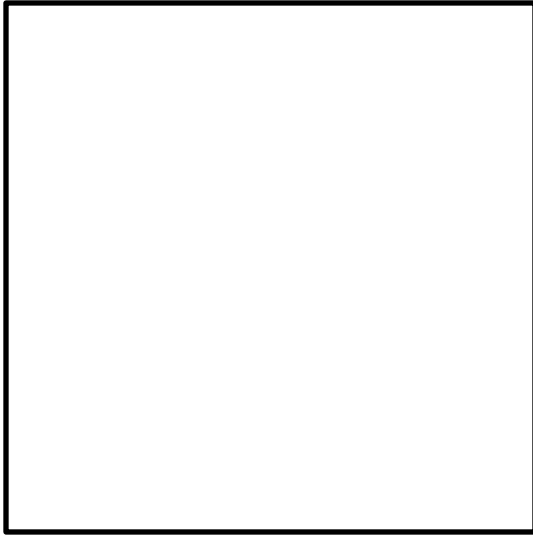

ocho

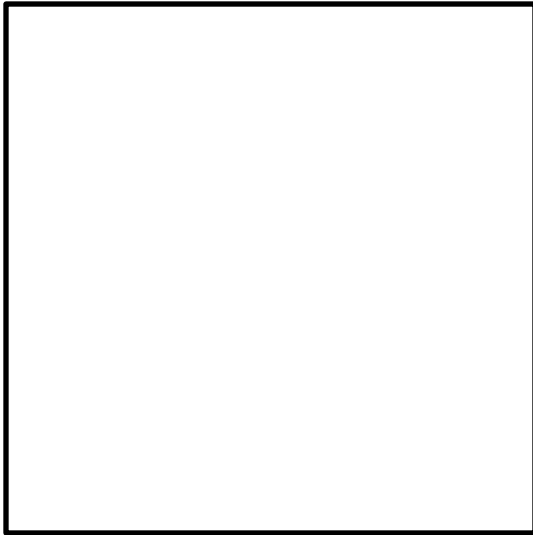

pecho

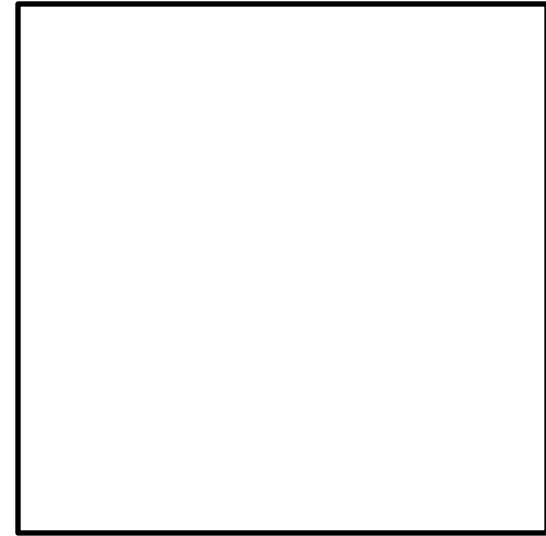

lichu

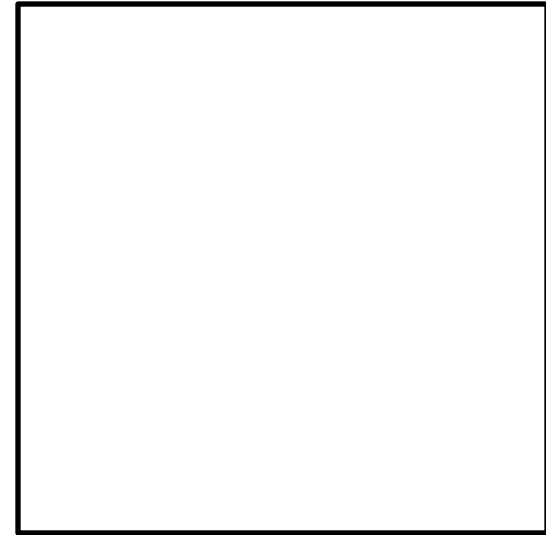

chocolate

REPASA, RECORTA Y PEGA LAS SÍLABAS PARA FORMAR LA PALABRA

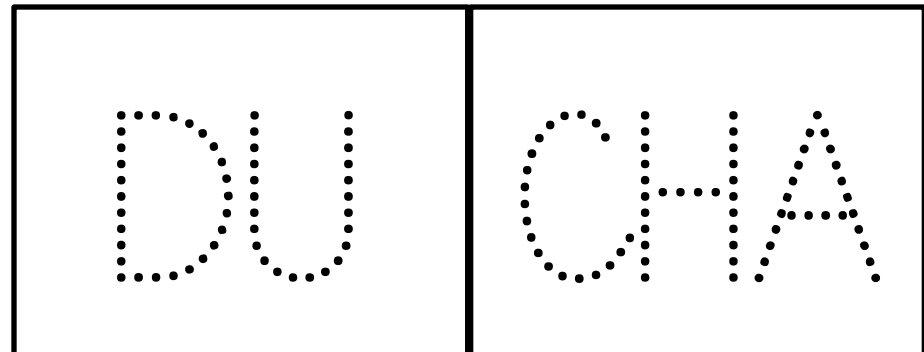
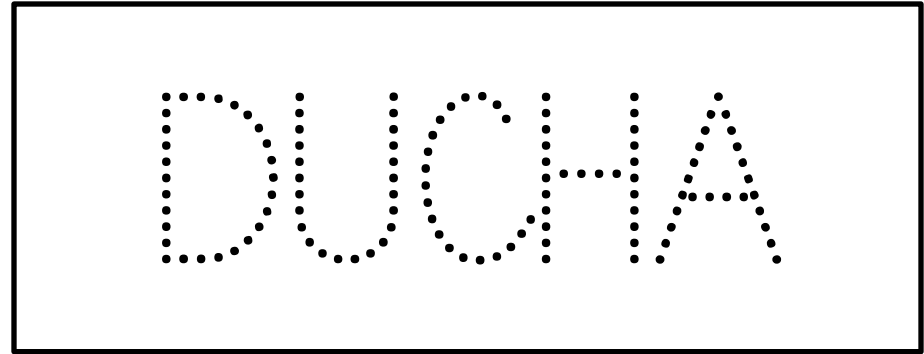
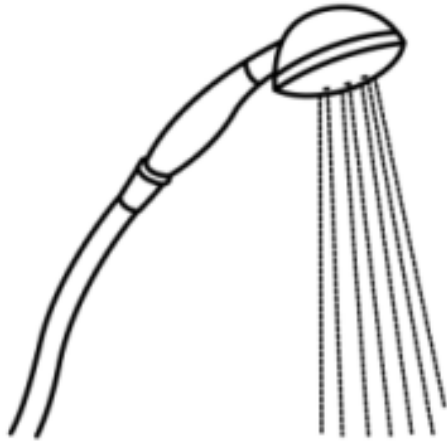

Repasa, recorta y pega las sílabas para formar la palabra

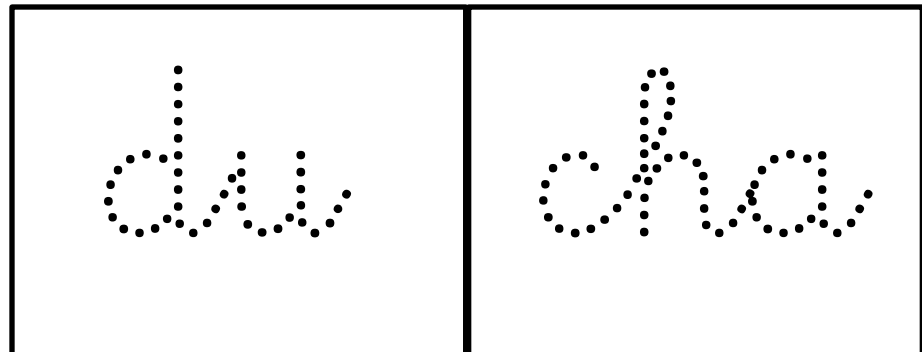
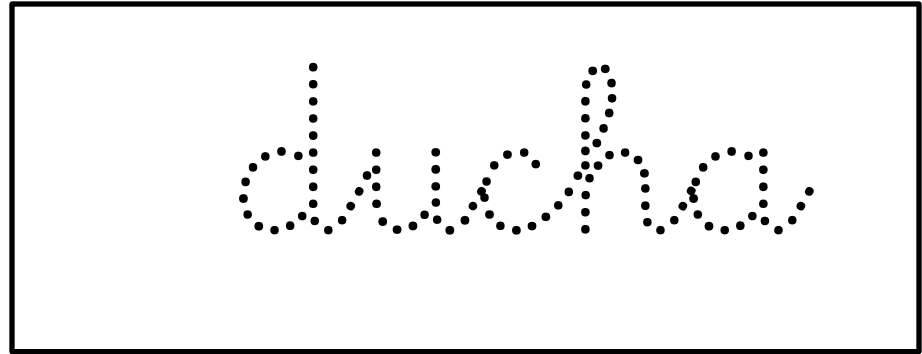
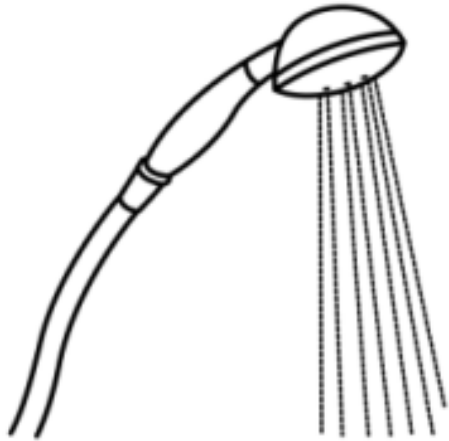

REPASA, RECORTA Y PEGA LAS SÍLABAS PARA FORMAR LA PALABRA

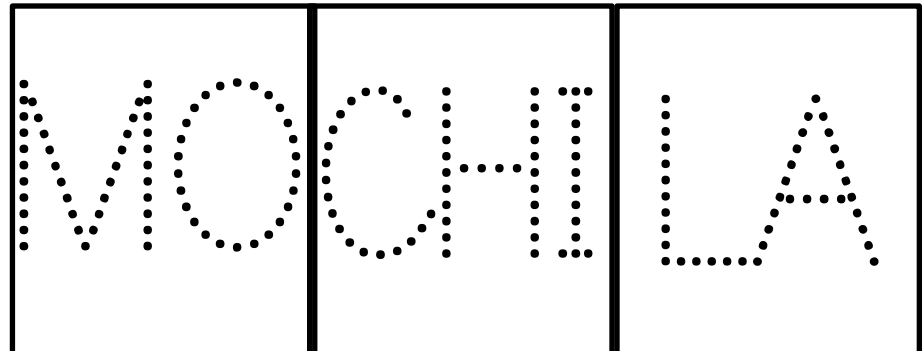
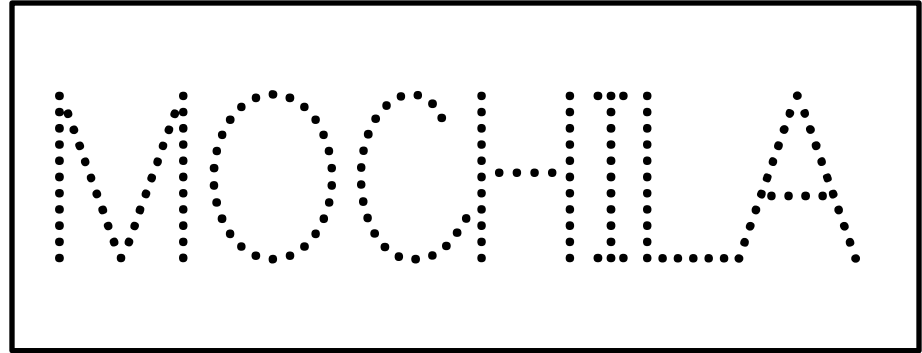

Repasa, recorta y pega las sílabas para formar la palabra

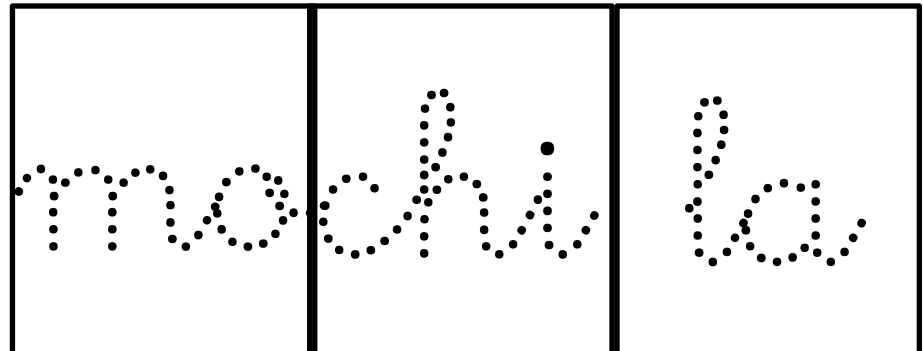
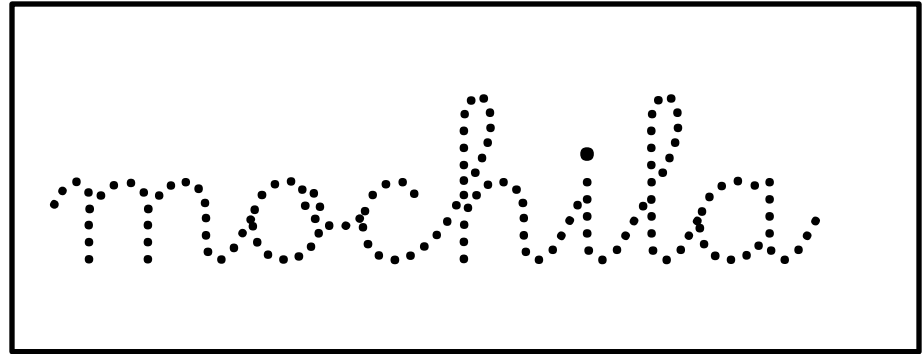

REPASA, RECORTA Y PEGA LAS SÍLABAS PARA FORMAR LA PALABRA

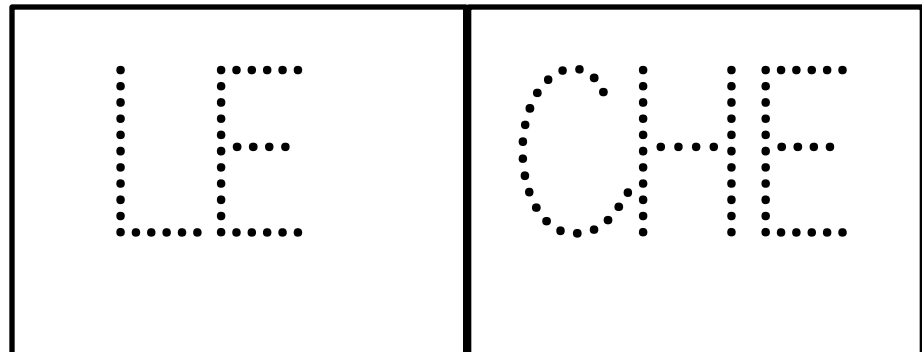
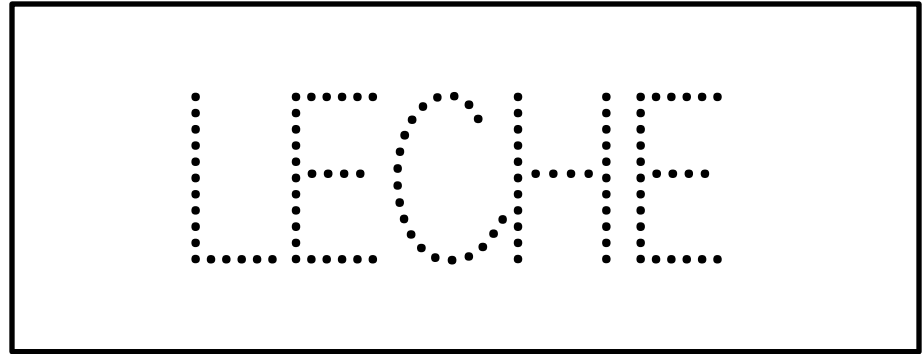

Repasa, recorta y pega las sílabas para formar la palabra

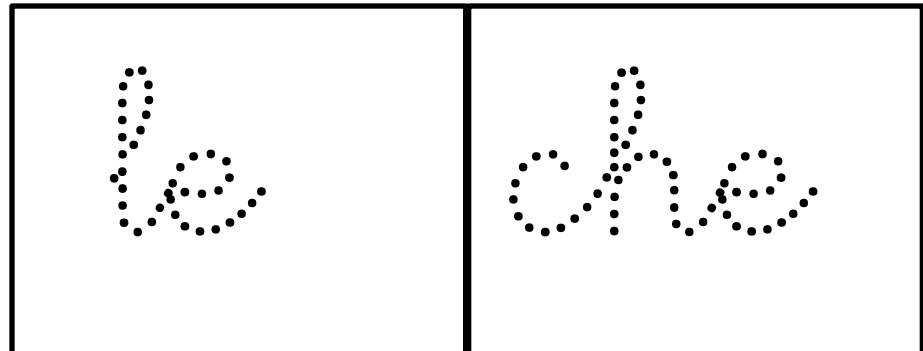
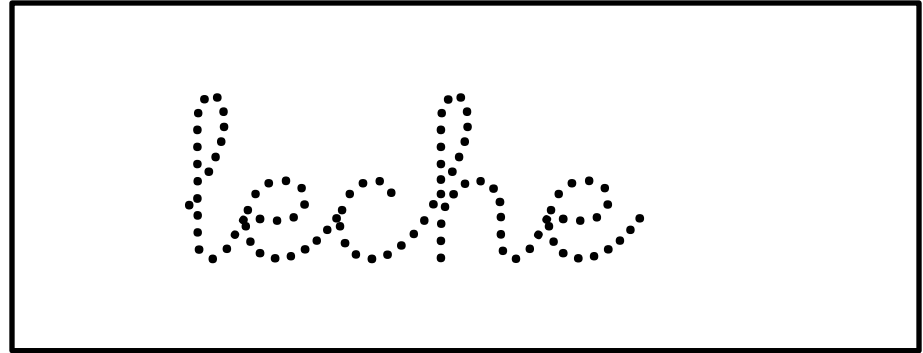

REPASA, RECORTA Y PEGA LAS SÍLABAS PARA FORMAR LA PALABRA

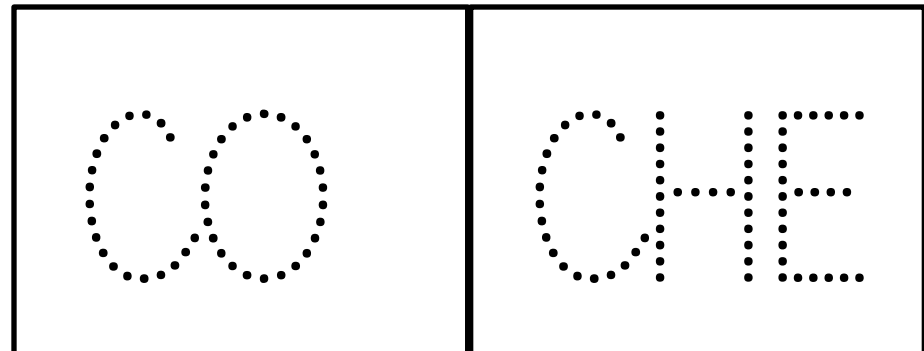
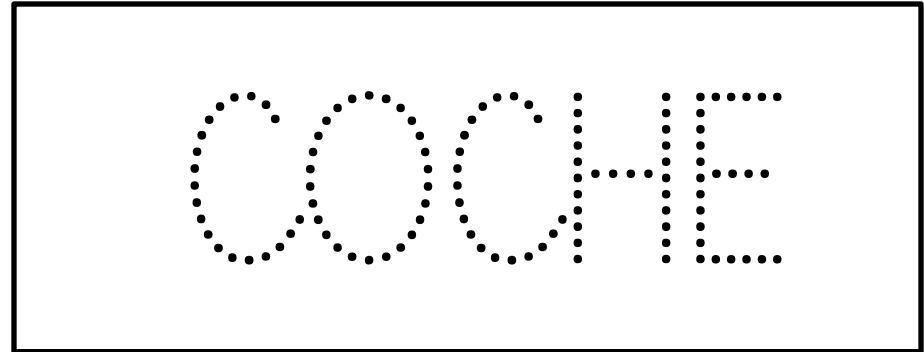
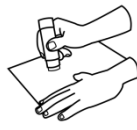

Repasa, recorta y pega las sílabas para formar la palabra

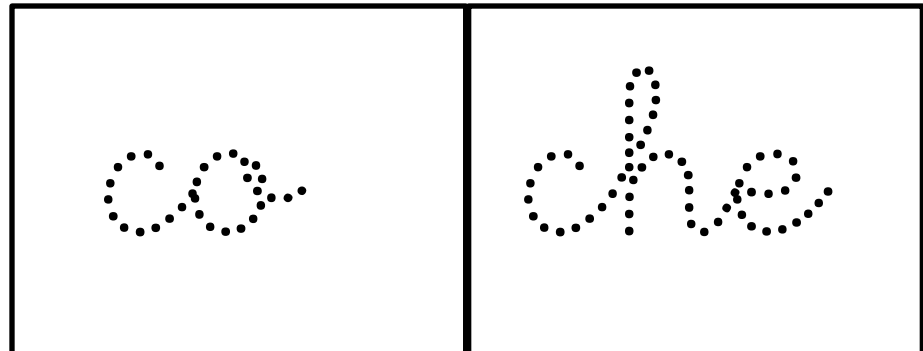
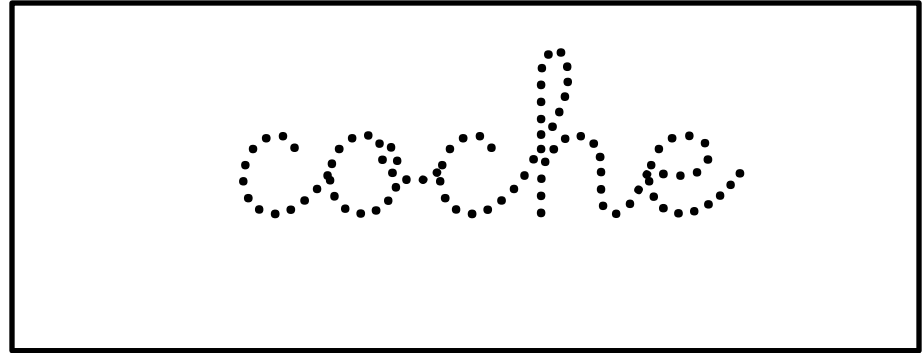
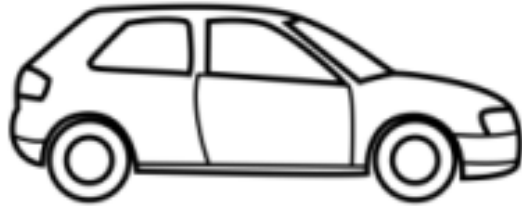

REPASA, RECORTA Y PEGA LAS SÍLABAS PARA FORMAR LA PALABRA

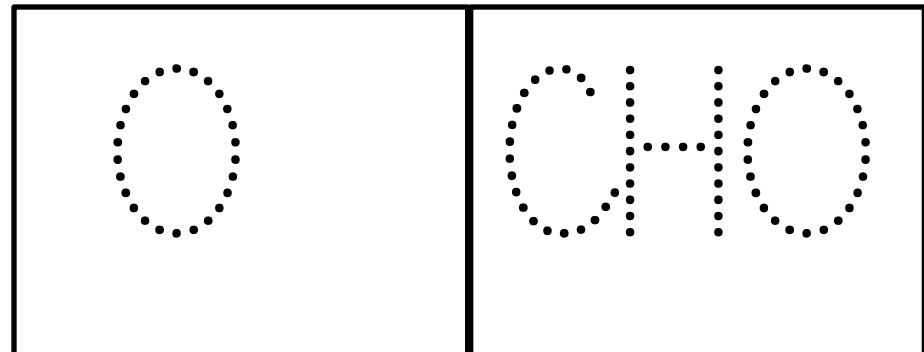
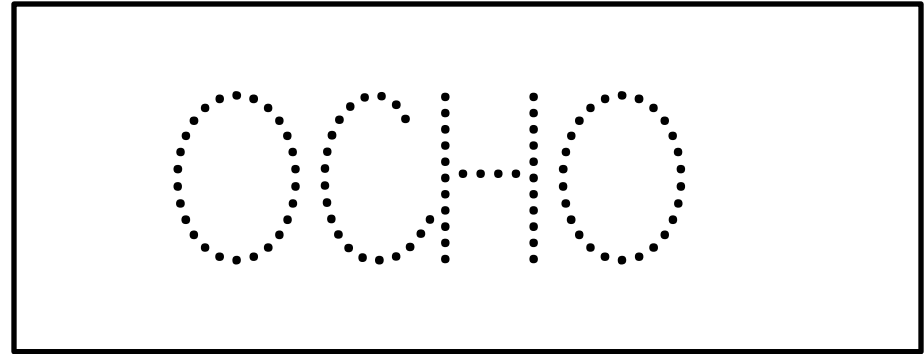

Repasa, recorta y pega las silabas para formar la palabra

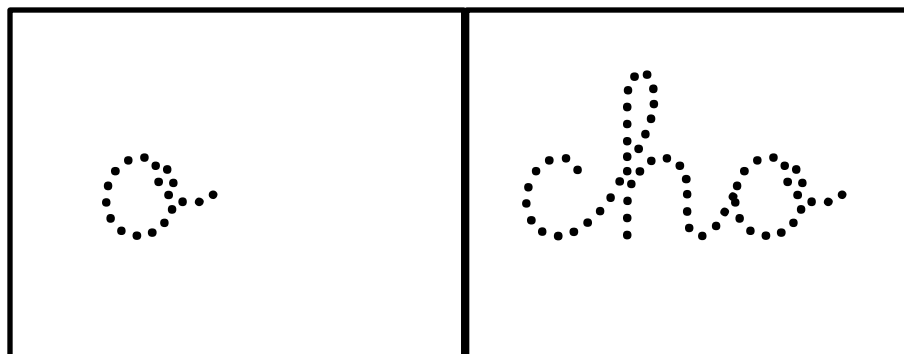
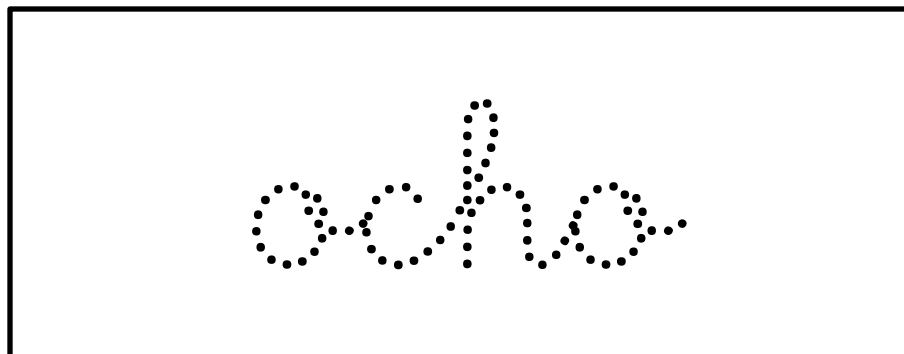

REPASA, RECORTA Y PEGA LAS SÍLABAS PARA FORMAR LA PALABRA



BICHOS

BI CHOS

Repasa, recorta y pega las sílabas para formar la palabra

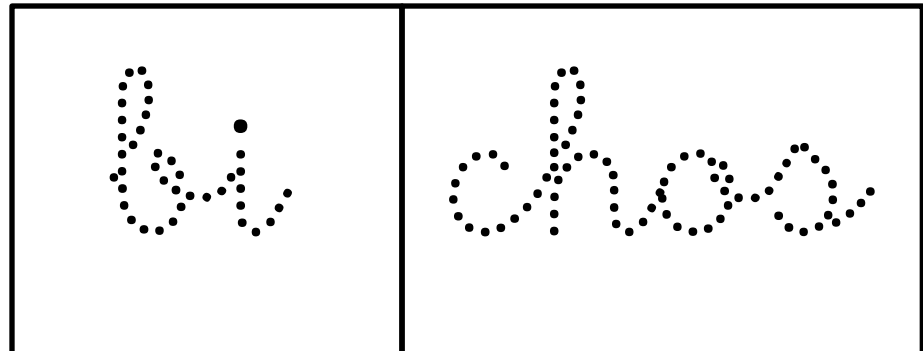
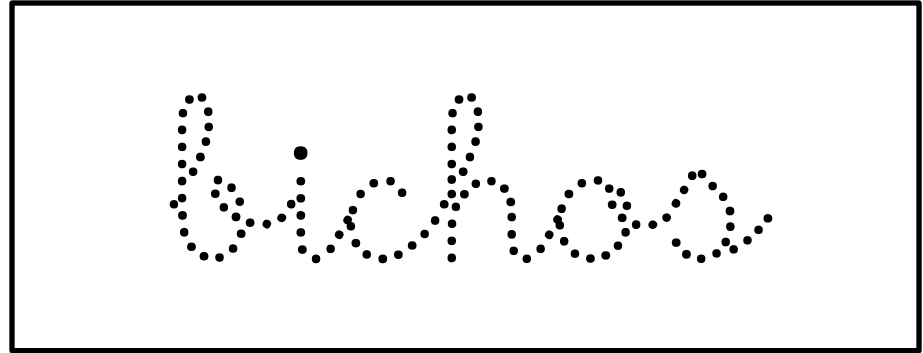

REPASA, RECORTA Y PEGA LAS SÍLABAS PARA FORMAR LA PALABRA

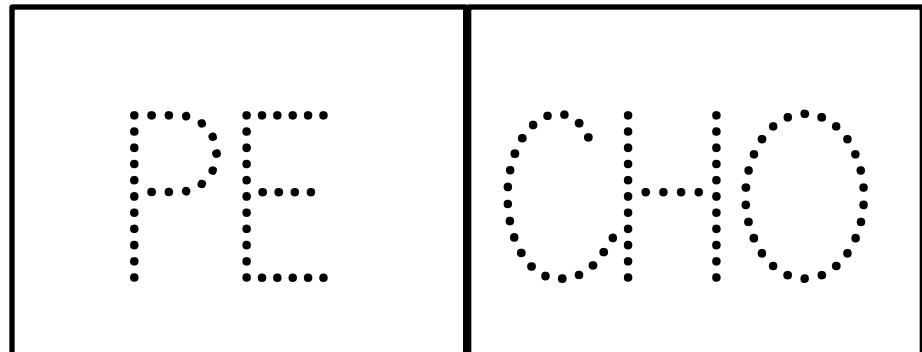
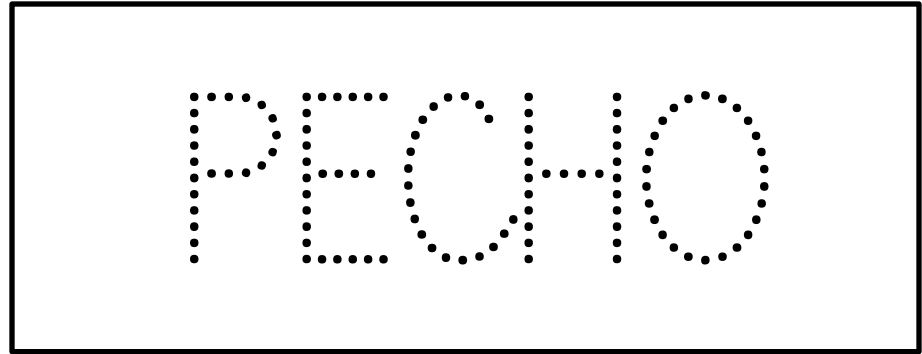
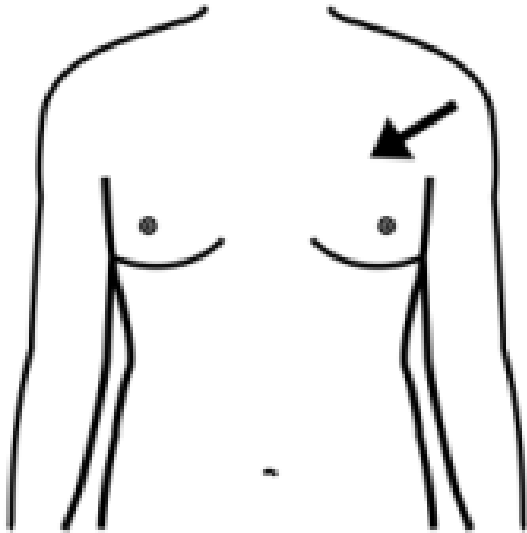

Repasa, recorta y pega las sílabas para formar la palabra

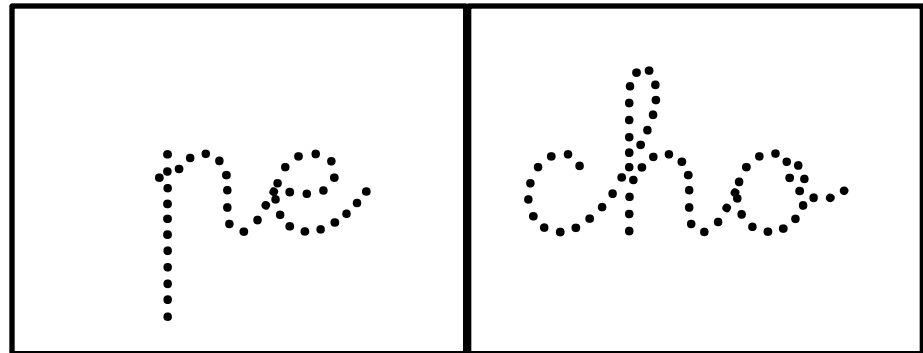
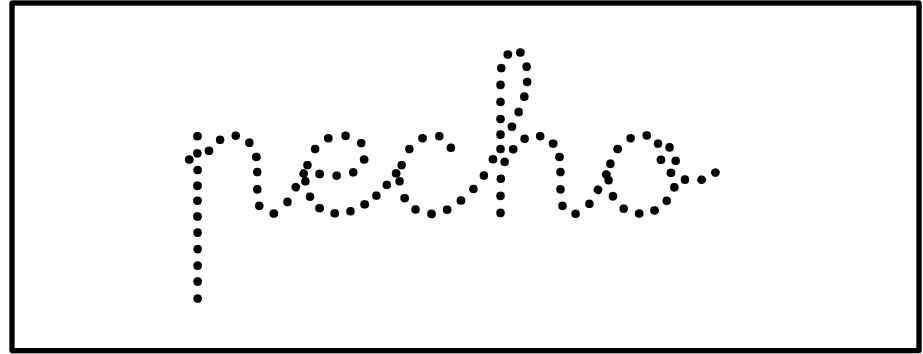
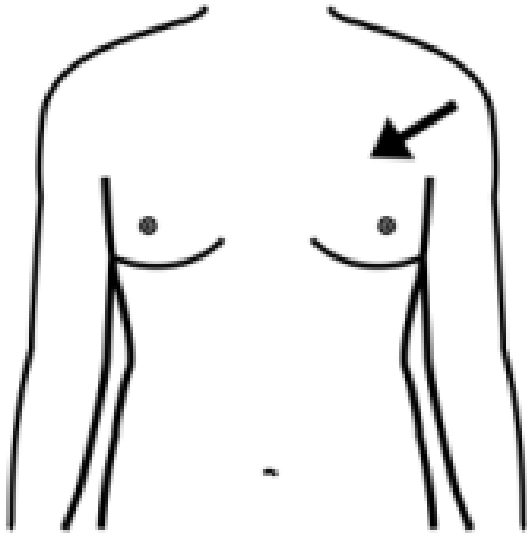

REPASA, RECORTA Y PEGA LAS SÍLABAS PARA FORMAR LA PALABRA

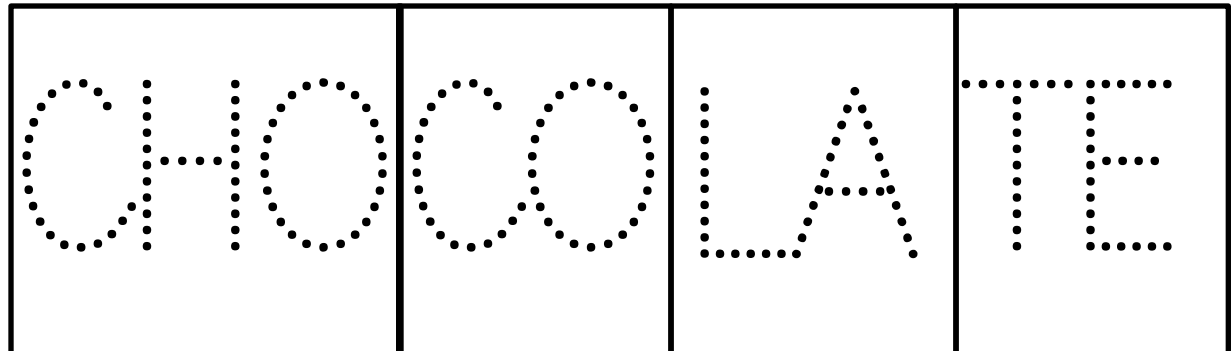
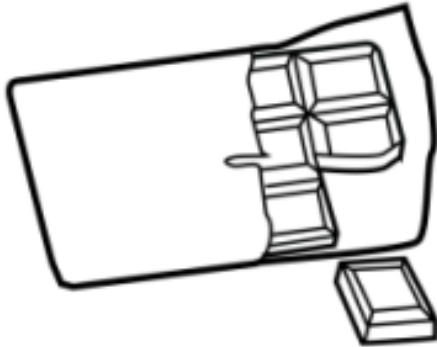
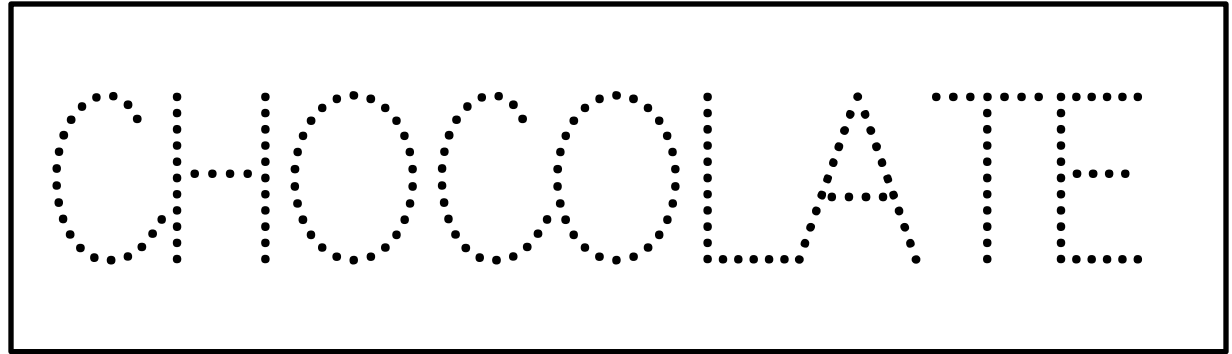

Repasa, recorta y pega las sílabas para formar la palabra

el Sol



chocolate

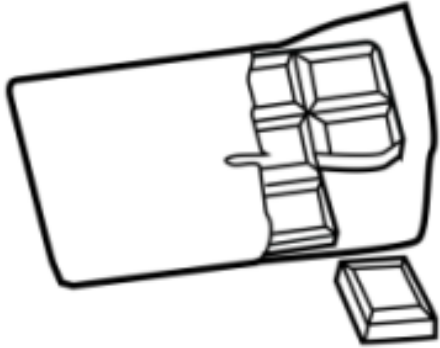

cho

co

la

te

RODEA CON UN CÍRCULO LAS SÍLABAS NECESARIAS PARA FORMAR CADA PALABRA

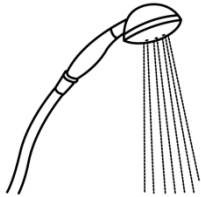

DU	JA
CA	CHA



MO	JO	LA
A	CHI	MO



SU	CHE
LE	BE

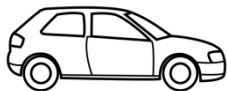

CO	CHE
ZU	MO

RODEA CON UN CÍRCULO LAS SÍLABAS NECESARIAS PARA FORMAR CADA PALABRA



A	CHO
O	TA



BI	CHOS
PI	LA

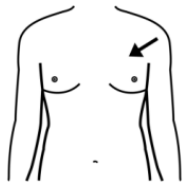

JO	CHO
PE	TA

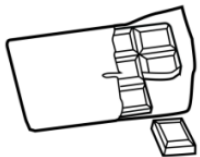

BA	JA	LA	JA
CHO	CO	TO	TE

Rodea las sílabas necesarias para formar cada palabra

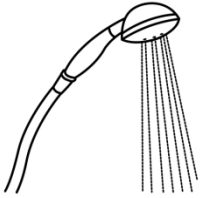

du	ja
ca	cha



mo	jo	la
a	chi	mo



su	che
le	be



co	che
zu	mo

Rodea las sílabas necesarias para formar cada palabra



a	cho
o	ta



li	chos
pi	la

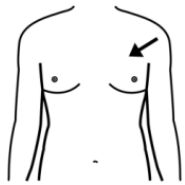

jo	cho
pe	ta

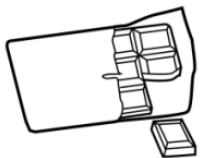

la	ja	la	ja
cho	co	to	te

ELIGE LAS LETRAS NECESARIAS PARA ESCRIBIR CADA PALABRA

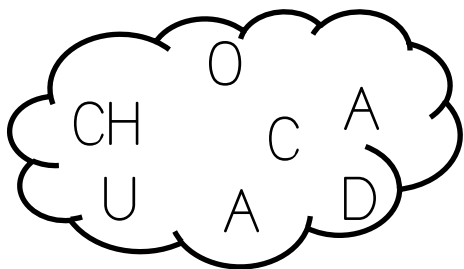
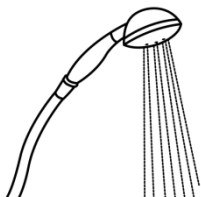

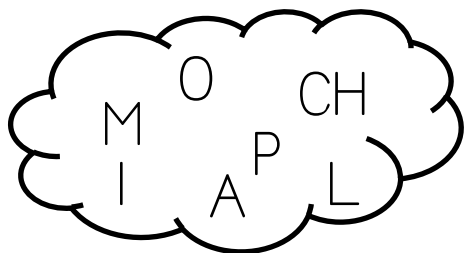

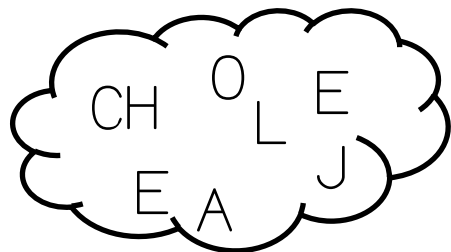

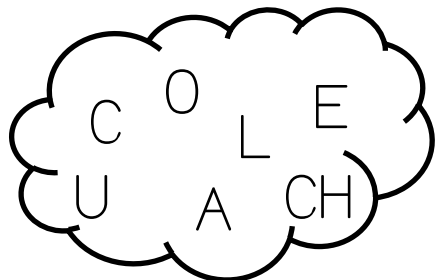
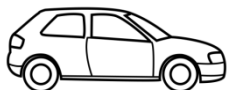

ELIGE LAS LETRAS NECESARIAS PARA ESCRIBIR CADA PALABRA

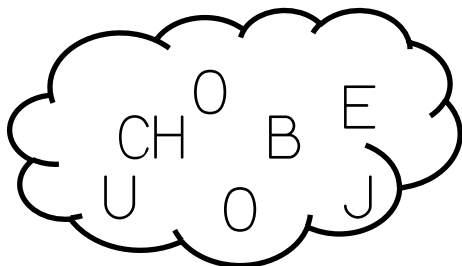

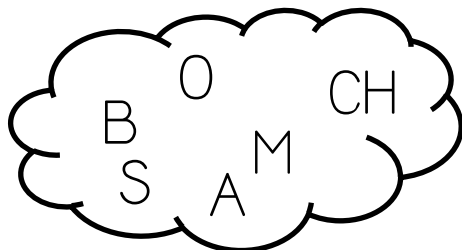

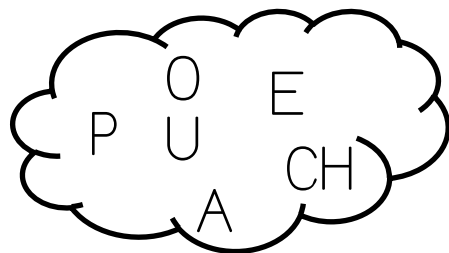
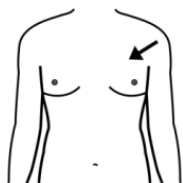

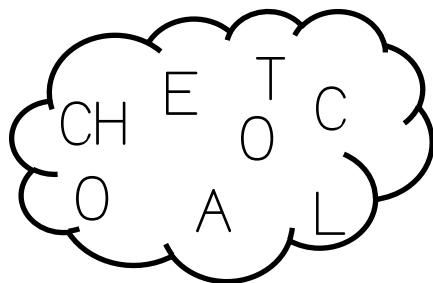
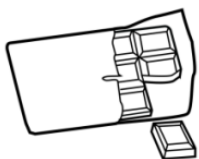

Elige las letras necesarias para escribir cada palabra

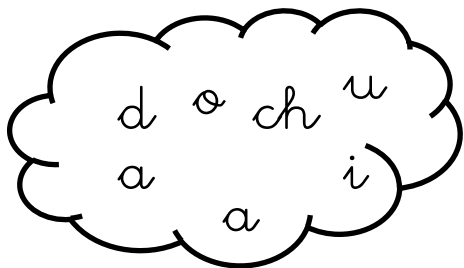
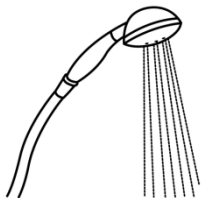

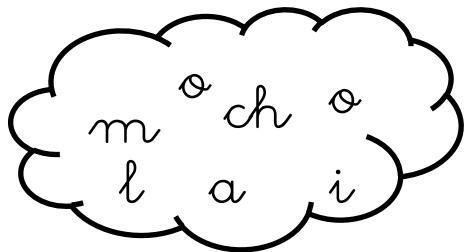

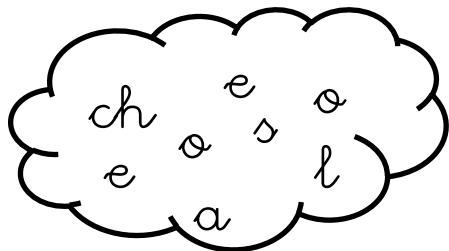



Elige las letras necesarias para escribir cada palabra





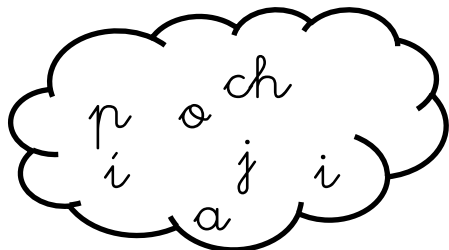
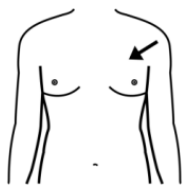

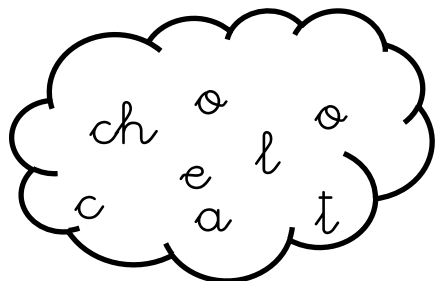
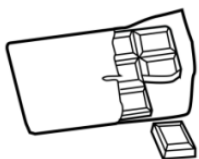

COMPLETA CON LAS VOCALES QUE FALTAN

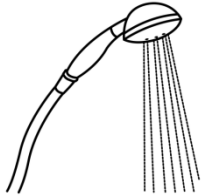
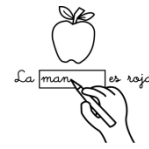

D ___ CH ___



___ CH ___



M ___ CH ___ L ___



B ___ CH ___ S



L ___ CH ___

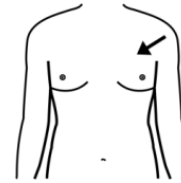

P ___ CH ___

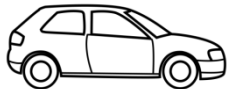

C ___ CH ___

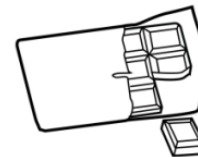

CH ___ C ___ L ___ T ___

Completa con las vocales que faltan

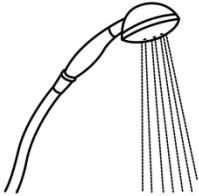
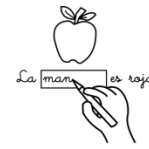

d ___ ch ___



___ ch ___



m ___ ch ___ l ___



b ___ ch ___ s



l ___ ch ___

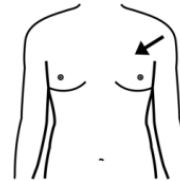

p ___ ch ___



c ___ ch ___

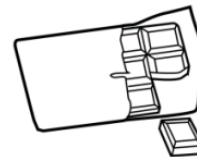

ch ___ c ___ l ___ t ___

COMPLETA CON LAS LETRAS QUE FALTAN

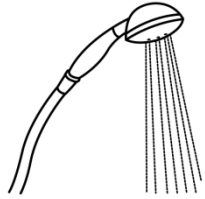
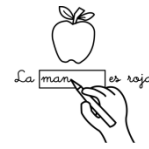

__ U __ A



O __ O



__ O __ I __ A



__ I __ O __



__ E __ E

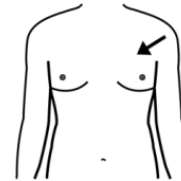

__ E __ O



__ O __ E

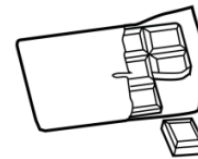

__ O __ O __ A __ E

Completa con las letras que faltan

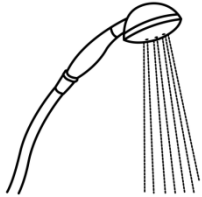
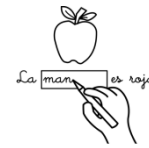

___ u ___ a



o ___ o



___ o ___ i ___ a



___ i ___ o ___



___ e ___ e

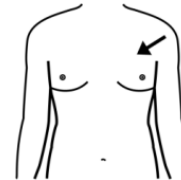

___ e ___ o



___ o ___ e

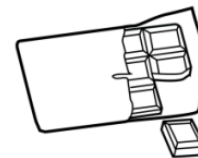

___ o ___ o ___ a ___ e

ESCRIBE EL NOMBRE

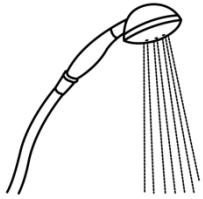









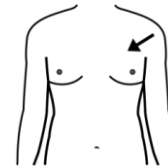



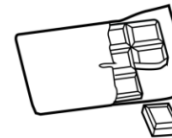

Escribe el nombre

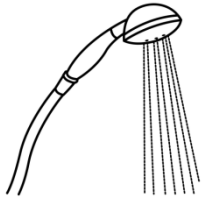









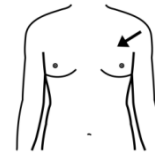



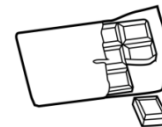

LEE LA FRASE Y CONTESTA



MAMÁ BEBE LECHE

¿QUIÉN ES?

¿QUÉ HACE?

¿QUÉ BEBE?

Lee la frase y contesta



Mamá bebe leche

¿Quién es?

¿Qué hace?

¿Qué bebe?

LEE LA FRASE Y CONTESTA



SANTIAGO COME CHOCOLATE

¿QUIÉN ES?

¿QUÉ HACE?

¿QUÉ COME?

Lee la frase y contesta



Santiago come chocolate

¿Quién es?

¿Qué hace?

¿Qué come?